

STAINLESS STEEL FEED-THROUGH WIREWAY, NEMA TYPE 4X



INDUSTRY STANDARDS

UL 870 Listed; File No. E27524

NEMA Type 4, 4X, 12
CSA, File No. 42184, Type 1
IEC 60529, IP66

APPLICATION

Stainless steel wireway protects wiring in applications that are regularly hosed down, very wet or highly corrosive. A complete selection of sections and fittings is available in multiple sizes for customization and design flexibility.

FEATURES

- Seams continuously welded and ground smooth
- No holes or knockouts
- Smooth, rounded edges on all sections and fittings
- Butt hinges and external screw clamps
- Oil-resistant gasket and adhesive

SPECIFICATIONS

- 16 gauge Type 304 stainless steel covers and bodies
- 10 gauge stainless steel flanges

FINISH

No. 2B finish.

Standard Product Selection Matrix

Description	4.00 x 4.00 in. (102 x 102 mm)	6.00 x 6.00 in. (152 x 152 mm)
12.00-in. (305-mm) Straight Section	F44W12SS ^{b,c}	F66W12SS ^{b,c}
24.00-in. (610-mm) Straight Section	F44W24SS ^{b,c}	F66W24SS ^{b,c}
36.00-in. (914-mm) Straight Section	F44W36SS ^{b,c}	F66W36SS ^{b,c}
48.00-in. (1219-mm) Straight Section	F44W48SS ^{b,c}	F66W48SS ^{b,c}
60.00-in. (1524-mm) Straight Section	F44W60SS ^{b,c}	F66W60SS ^{b,c}
120.00-in. (3048-mm) Straight Section	F44W120SS ^{b,c}	F66W120SS ^{b,c}
Flexible Fitting	F44WFFSS	F66WFFSS
Telescope Fitting	F44WASS	F66WASS
45° Elbow	F44WE45SS ^{b,c}	F66WE45SS ^{b,c}
90° Elbow	F44WE90SS ^{b,c}	F66WE90SS ^{b,c}
Tee	F44WTSS ^{b,c}	F66WTSS ^{b,c}
Closure Plate	F44WPSS	F66WPSS
Reducer Bushings: 6.00-in. (152-mm) to 4.00-in. (102-mm) Center Hole	—	F66WR44SS
Reducer Bushings: 6.00-in. (152-mm) to 4.00-in. (102-mm) Edge Hole	—	F66WRE44SS
6.00-in. (152-mm) Nipple	F44WN6SS ^b	F66WN6SS ^{b,c}
Swivel Nipple (Regular)	F44WSCSS ^{b,c}	—
Drop Hanger	F44HDSS	F66HDSS
Bracket Hanger	F44HBSS	F66HBSS
Box Connector	F44WBSS	F66WBSS
Gasket and Screws ^a	F44WGSS	F66WGSS

^aStandard packages of wireway contain one gasket and one set of screws to join sections, except "Tee" fittings which contain two of each, and "Telescope" fittings which contain none. Additional gasket and screw sets may be ordered by catalog number.

^bCertified by Canadian Standards Association.

^cUL 870

TELESCOPE FITTING

Length is easily adjustable from 1.50 in. (38 mm) to 13.50 in. (343 mm). No cutting or welding required.

BULLETIN: F22

Catalog Number	AxB in./mm
F44WASS	4.00 x 4.00 102 x 102
F66WASS	6.00 x 6.00 152 x 152

All dimensions are to outside surfaces. Allow .12 in. (3 mm) additional for gasket at joints.

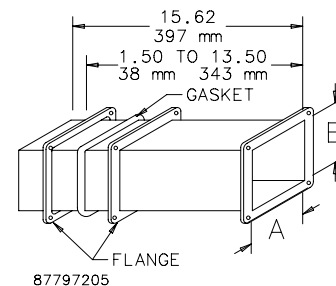

STRAIGHT SECTION

Available in lengths from 12.00 in. (305 mm) to 120.00 in. (3048 mm).

BULLETIN: F22

Catalog Number	AxBxC in.	AxBxC mm	D (in.)	D (mm)	E (in.)	E (mm)
F44W12SS	4.00 x 4.00 x 12.00	102 x 102 x 305	5.38	137	5.38	137
F44W24SS	4.00 x 4.00 x 24.00	102 x 102 x 610	5.38	137	5.38	137
F44W36SS	4.00 x 4.00 x 36.00	102 x 102 x 914	5.38	137	5.38	137
F44W48SS	4.00 x 4.00 x 48.00	102 x 102 x 1219	5.38	137	5.38	137
F44W60SS	4.00 x 4.00 x 60.00	102 x 102 x 1524	5.38	137	5.38	137
F44W120SS	4.00 x 4.00 x 120.00	102 x 102 x 3048	5.38	137	5.38	137
F66W12SS	6.00 x 6.00 x 12.00	152 x 152 x 305	7.62	194	7.62	194
F66W24SS	6.00 x 6.00 x 24.00	152 x 152 x 610	7.62	194	7.62	194
F66W36SS	6.00 x 6.00 x 36.00	152 x 152 x 914	7.62	194	7.62	194
F66W48SS	6.00 x 6.00 x 48.00	152 x 152 x 1219	7.62	194	7.62	194
F66W60SS	6.00 x 6.00 x 60.00	152 x 152 x 1524	7.62	194	7.62	194
F66W120SS	6.00 x 6.00 x 120.00	152 x 152 x 3048	7.62	194	7.62	194

All dimensions are to outside surfaces. Allow .12 in. (3 mm) additional for gasket at joints.

Certified by Canadian Standards Association.

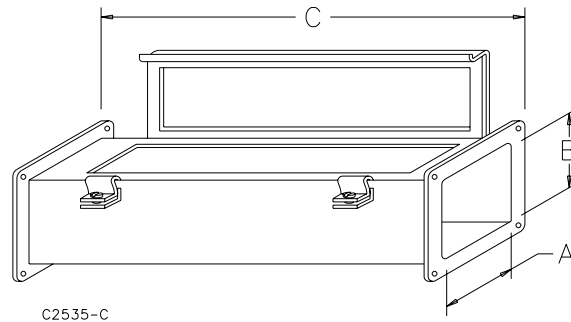

Flange Detail

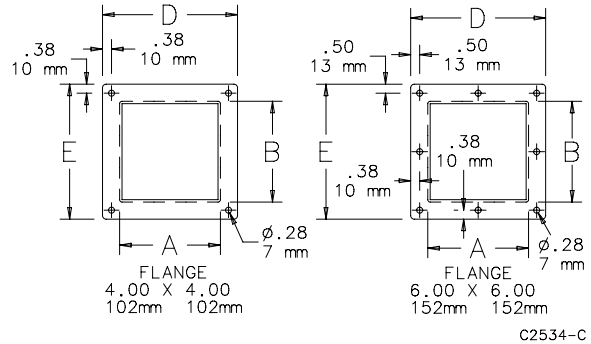

FLEXIBLE FITTING

Isolates a wireway run from shock and vibration. Compensates for misalignment. Used where an odd angle is required (but not to exceed 90 degrees). Permits movement of a machine or control station connected to a wireway run. Hypalon bellow with steel flanges.

BULLETIN: F22

Catalog Number	AxB in./mm
F44WFFSS	4.00 x 4.00 102 x 102
F66WFFSS	6.00 x 6.00 152 x 152

All dimensions are to outside surfaces. Allow .12 in. (3 mm) additional for gasket at joints.

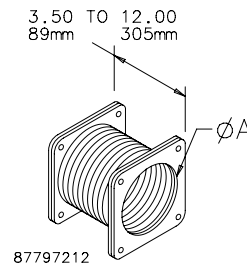

45-DEGREE ELBOW

BULLETIN: F22

Catalog Number	AxB in./mm	H in./mm	J in./mm
F44WE45SS	4.00 x 4.00 102 x 102	3.25 83	2.44 62
F66WE45SS	6.00 x 6.00 152 x 152	4.25 108	3.00 76

All dimensions are to outside surfaces. Allow .12 in. (3 mm) additional for gasket at joints. Dimension J is from intersection of center lines.

Certified by Canadian Standards Association.

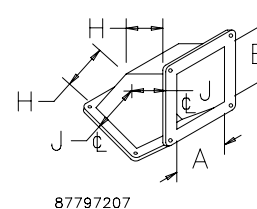

GASKET AND SCREWS

Standard packages of wireway contain one gasket and one set of screws to join sections, except Tee Fittings which contain two of each and Telescope Fittings which contain none. Additional gasket and screw sets may be ordered by catalog number.

90-DEGREE ELBOW

BULLETIN: F22

Catalog Number	AxB in./mm	F in./mm	K in./mm
F44WE90SS	4.00 x 4.00 102 x 102	7.00 178	5.00 127
F66WE90SS	6.00 x 6.00 152 x 152	9.00 229	6.00 152

All dimensions are to outside surfaces. Allow .12 in. (3 mm) additional for gasket at joints. Dimension K is from intersection of center lines.

Certified by Canadian Standards Association.

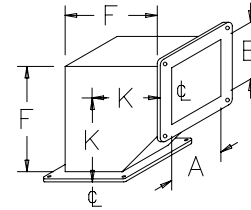

87797206

TEE

BULLETIN: F22

Catalog Number	AxB in./mm	F in./mm	G in./mm	K in./mm
F44WTSS	4.00 x 4.00 102 x 102	7.00 178	10.00 254	5.00 127
F66WTSS	6.00 x 6.00 152 x 152	9.00 229	12.00 305	6.00 152

All dimensions are to outside surfaces. Allow .12 in. (3 mm) additional for gasket at joints. Dimension K is from intersection of center lines.

Certified by Canadian Standards Association.

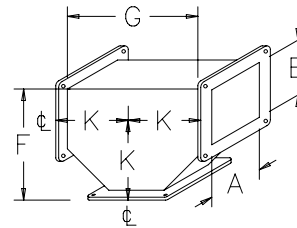

87797208

CLOSURE PLATE

Used to seal the end of a wireway section or run.

BULLETIN: F22

Catalog Number	D in./mm	E in./mm
F44WPSS	5.38 137	5.38 137
F66WPSS	7.62 194	7.62 194

Note: All dimensions are to outside surfaces. Allow .12 in. (3mm) additional for gasket at joints.

Certified by Canadian Standards Association.

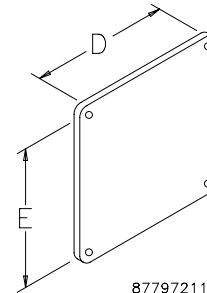

87797211

REDUCER BUSHINGS

Used to reduce to a smaller wireway size. The center hole bushing centers the two wireway sizes relative to each other while the edge hole bushing keeps the top surfaces even.

BULLETIN: F22

Center Hole

Catalog Number	AxB in./mm	D in./mm	E in./mm
F66WR44SS	4.00 x 4.00 102 x 102	7.62 194	7.62 194

All dimensions are to outside surfaces. Allow .12 in. (3 mm) additional for gasket at joints.

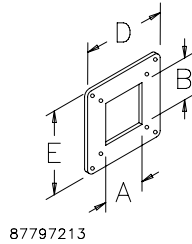

Edge Hole

Catalog Number	AxB in./mm	D in./mm	E in./mm
F66WRE44SS	4.00 x 4.00 102 x 102	7.62 194	7.62 194

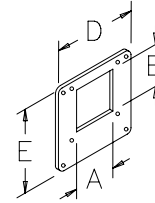

87797214

NIPPLE

Available in 6.00-in. (152-mm) length.

BULLETIN: F22

Catalog Number	AxBxC in./mm
F44WN6SS	4.00 x 4.00 x 6.00 102 x 102 x 152
F66WN6SS	6.00 x 6.00 x 6.00 152 x 152 x 152

All dimensions are to outside surfaces. Allow .12 in. (3 mm) additional for gasket at joints.

Certified by Canadian Standards Association.

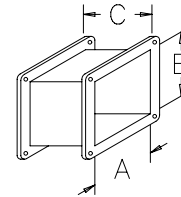

87797204

SWIVEL NIPPLE

Allows wireway run to be adjusted to any angle. Regular type is used between adjacent wireway sections or fittings.

BULLETIN: F22

Catalog Number	AxB in./mm
F44WSCSS	4.00 x 4.00 102 x 102

All dimensions are to outside surfaces. Allow .12 in. (3 mm) additional for gasket at joints.

Certified by Canadian Standards Association.

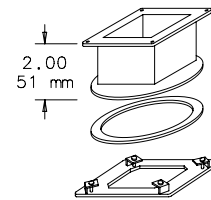

87797209

DROP HANGER

BULLETIN: F22

Catalog Number	S in./mm	T in./mm
F44HDSS	11.75 298	6.00 152
F66HDSS	15.25 387	8.12 206

All dimensions are to outside surfaces. Allow .12 in. (3 mm) additional for gasket at joints.

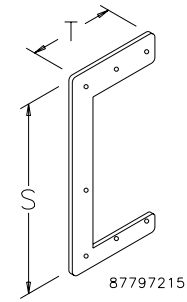

BRACKET HANGER

BULLETIN: F22

Catalog Number	P in./mm	R in./mm	U in./mm
F44HBSS	6.12 155	3.62 92	5.88 149
F66HBSS	8.25 210	3.62 92	7.88 200

All dimensions are to outside surfaces. Allow .12 in. (3 mm) additional for gasket at joints.

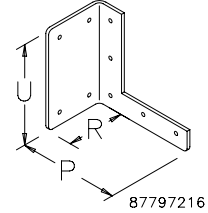

BOX CONNECTOR

When wireway enters an enclosure, a box connector should be used on the inside of the enclosure to ensure a tight and stable seal.

BULLETIN: F22

Catalog Number	D in./mm	E in./mm
F44WBSS	5.38 137	5.38 137
F66WBSS	7.62 194	7.62 194

All dimensions are to outside surfaces. Allow .12 in. (3 mm) additional for gasket at joints.

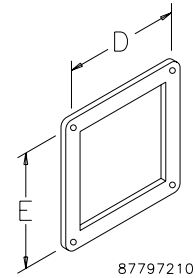

Notes